

The Unexpected Role of Calcium-Activated Potassium Channels: Limitation of NO-Induced Arterial Relaxation

Johannes Schmid, MD;* Bettina Müller, PhD;* David Heppeler, BS; Dina Gaynullina, PhD; Mario Kassmann, PhD; Hristo Gagov, PhD; Mitko Mladenov, PhD; Maik Gollasch, MD, PhD; Rudolf Schubert, MD, PhD

Background—Multiple studies have shown that an NO-induced activation of vascular smooth muscle BK channels contributes to the NO-evoked dilation in many blood vessels. In vivo, NO is released continuously. NO attenuates vessel constrictions and, therefore, exerts an anticontractile effect. It is unknown whether the anticontractile effect of continuously present NO is mediated by BK channels.

Methods and Results—This study tested the hypothesis that BK channels mediate the vasodilatory effect of continuously present NO. Experiments were performed on rat and mouse tail and rat saphenous arteries using isometric myography and FURA-2 fluorimetry. Continuously present NO donors, as well as endogenous NO, attenuated methoxamine-induced vasoconstrictions. This effect was augmented in the presence of the BK channel blocker iberiotoxin. Moreover, the contractile effect of iberiotoxin was reduced in the presence of NO donors. The effect of the NO donor sodium nitroprusside was abolished by an NO scavenger and by a guanylyl cyclase inhibitor. In addition, the effect of sodium nitroprusside was reduced considerably by a protein kinase G inhibitor, but was not altered by inhibition of H₂S generation. Sodium nitroprusside attenuated the intracellular calcium concentration response to methoxamine. Furthermore, sodium nitroprusside strongly reduced methoxamine-induced calcium influx, which depends entirely on L-type calcium channels. It did not affect methoxamine-induced calcium release.

Conclusions—In summary, this study demonstrates the following: (1) continuously present NO evokes a strong anticontractile effect on rat and mouse arteries; (2) the iberiotoxin-induced augmentation of the effect of NO is associated with an NO-induced reduction of the effect of iberiotoxin; and (3) NO evoked a reduction of calcium influx via L-type calcium channels. (*J Am Heart Assoc.* 2018;7:e007808. DOI: 10.1161/JAHA.117.007808.)

Key Words: artery • NO • potassium channels • vascular tone regulation

Calcium-activated potassium channels of high conductance (BK; Kca1.1) are expressed ubiquitously in smooth muscle tissues, especially in vascular smooth muscle. The activity of vascular smooth muscle BK channels is regulated by a large number of intracellular signaling pathways.^{1,2} In the vascular system, BK channels have served as a brake on vasoconstriction induced by transmural pressure, as well as

by several contractile agonists. Furthermore, they are mediators of vasodilation induced by several relaxing agonists.

NO is a powerful vasodilator and an antiproliferative and anti-inflammatory agent. The vasodilatory effect of NO is mediated mostly by soluble guanylyl cyclase, which produces cGMP,³ activating PKG (protein kinase G). PKG, in turn, phosphorylates several different proteins,⁴ particularly BK

From the Centre for Biomedicine and Medical Technology Mannheim and European Center of Angioscience, Research Division Cardiovascular Physiology, Medical Faculty Mannheim, Heidelberg University, Mannheim, Germany (J.S., B.M., D.H., D.G., H.G., M.M., R.S.); Experimental and Clinical Research Center, a joint cooperation between the Charité Medical Faculty and the Max Delbrück Center for Molecular Medicine, Berlin, Germany (M.K., M.G.); Faculty of Biology, M.V. Lomonosov Moscow State University, Moscow, Russia (D.G.); and Department of Physiology, Russian National Research Medical University, Moscow, Russia (D.G.).

Accompanying Tables S1 through S12 are available at <http://jaha.ahajournals.org/content/7/7/e007808/DC1/embed/inline-supplementary-material-1.pdf>

*Dr Schmid and Dr Müller contributed equally to this work as co-first authors.

Hristo Gagov is currently located at the Department of Animal and Human Physiology, St. Kliment Ohridski University, Sofia, Bulgaria.

Mitko Mladenov is currently located at the Institute of Biology, Faculty of Natural Sciences and Mathematics, Sts. Cyril and Methodius, University of Skopje, Skopje, Macedonia.

Correspondence to: Rudolf Schubert, MD, PhD, Cardiovascular Physiology, Centre for Biomedicine and Medical Technology Mannheim and European Center of Angioscience, Medical Faculty Mannheim, Ruprecht-Karls-University Heidelberg, Ludolf-Krehl-Strasse 13-17, 68167 Mannheim, Germany. E-mail: rudolf.schubert@medma.uni-heidelberg.de

Received December 14, 2017; accepted February 14, 2018.

© 2018 The Authors. Published on behalf of the American Heart Association, Inc., by Wiley. This is an open access article under the terms of the Creative Commons Attribution-NonCommercial-NoDerivs License, which permits use and distribution in any medium, provided the original work is properly cited, the use is non-commercial and no modifications or adaptations are made.

Clinical Perspective

What Is New?

- Continuously present NO evokes a strong anticontractile effect on several arteries.
- This effect is limited by smooth muscle BK channels because of an NO-induced reduction of calcium influx via L-type calcium channels.

What Are the Clinical Implications?

- In several diseases, such as hypertension and diabetes mellitus, an impaired BK channel function has been observed.
- Previously, the latter was considered to lead to a reduced NO-induced vasodilation.
- The new data propose that the opposite may be the case.

channels.^{5,6} Alternatively, NO has been reported to directly modulate BK channels.⁷ Multiple studies have shown that an NO-induced activation of vascular smooth muscle BK channels contributes to the NO-evoked dilation in many blood vessels^{8–11} (additional studies listed and discussed by Tanaka et al¹²).

In vivo, the bloodstream is continually exerting shear stress on the vessel wall, leading to a continuous release of NO. The vessel wall is, therefore, constantly exposed to NO. NO then attenuates vessel constrictions induced by, for example, transmitters released from nerve endings or circulating hormones: NO exerts an anticontractile effect. It is unknown whether the anticontractile effect of continuously present NO is also mediated by BK channels. This question may not seem exciting in light of the overwhelming evidence demonstrating that BK channels mediate vasodilation induced by NO (see studies listed and discussed by Tanaka et al¹²). However, even in these studies, reported findings have varied. Indeed, the BK channel blockers charybdotoxin or iberiotoxin did not affect S-nitroso-N-acetylpenicillamine-induced relaxation of guinea pig aorta and carotid arteries,¹³ 3-morpholino-sydnonimine-induced hyperpolarization of rabbit mesenteric arteries,¹⁴ sodium nitroprusside (SNP)-induced hyperpolarization of guinea pig carotid arteries,¹⁵ and 3-morpholino-sydnonimine-induced relaxation of rabbit carotid arteries.¹⁶ Thus, a contribution of the BK channel to the vasodilatory effect of NO cannot be predicted clearly, even less so for the never studied anticontractile effect of permanently present NO. Therefore, this study tested the hypothesis that BK channels mediate the vasodilatory effect of continuously present NO.

Methods

The data, analytic methods, and study materials will be made available to other researchers for purposes of reproducing the

results or replicating the procedure. The authors declare that all supporting data are available within the article (and its online supplementary files).

Animals

This investigation conforms with the *US Guide for the Care and Use of Laboratory Animals* (8th edition, National Academy of Sciences, 2011) and institutional guidelines. A governmental committee on animal welfare granted approval for the use of laboratory animals in this study. Male, 8 to 12 weeks old, Wistar rats (n=267) and male, 6 to 10 weeks old, C57BL/6 mice (n=15) were obtained from Janvier (France). Male, 6 to 10 weeks old, BK β 1-deficient mice (n=17) (targeted disruption of BK channel β 1 locus: exon 1 deleted) were kindly provided by Prof. Olaf Pongs (University Hamburg) and have been described previously.¹⁷ The animals were provided with food and water ad libitum and were housed under standardized conditions in a room with a controlled temperature (22°C) and a 12-hour light-dark cycle.

Vessel Preparation

The rats were euthanized under CO₂ narcosis by decapitation, and mice were euthanized under isoflurane narcosis by decapitation. The tail and the lower extremity (limb) were quickly removed and placed in an ice-cold physiological saline solution of the following composition (in mmol/L): 145 NaCl, 4.5 KCl, 1.2 NaH₂PO₄, 0.1 CaCl₂, 1.0 MgSO₄, 0.025 EDTA, and 5 HEPES (pH 7.4). The tail and saphenous arteries were isolated by removing all surrounding tissues. Small vessel rings (2 mm in length) were used for further experiments. The rat tail artery was selected because we had characterized vascular smooth muscle BK channel properties and regulation previously.^{18,19} Although not being used in studies on BK channels, the rat saphenous artery has been used intensively in other projects and was, therefore, also chosen for the present study.^{20,21}

Isometric Mounting of Vessels

For the recording of isometric tension, isolated vessels were mounted onto 2 stainless steel wires in a wire myograph (model 610M; Danish Myotechnology, Denmark) filled with physiological salt solution (PSS), consisting of (in mmol/L): 120 NaCl, 4.5 KCl, 1.2 NaH₂PO₄, 1.0 MgSO₄, 1.6 CaCl₂, 0.025 EDTA, 5.5 glucose, 26 NaHCO₃, and 5 HEPES at pH 7.4 oxygenated with carbogen (95% O₂ and 5% CO₂) at 37°C. Data acquisition and analysis were performed using Labchart (ADInstruments). The vessels were stretched to their optimal lumen diameter (90% of the diameter they would have at a transmural pressure of 100 mm Hg²²). Viability of the vessels

was tested with the following: (1) methoxamine at 10^{-5} mol/L to test smooth muscle cell function; and (2) acetylcholine at 10^{-5} mol/L after precontraction with 10^{-6} mol/L methoxamine to test endothelial cell function. In some experiments, a solution containing 120 mmol/L KCl was used, which was prepared on the basis of PSS by equimolar replacement of NaCl. All vessel tension data were normalized to the tension developed in response to 10^{-5} mol/L methoxamine, applied after the viability test. In most cases, the vessel response of interest was a cumulative concentration-response relationship to methoxamine. Herein, the response of the vessel to a particular concentration of methoxamine, except the lowest one, was dependent on the response to the preceding methoxamine concentration. To avoid dealing with interdependent data during statistical analysis, the concentration-response relationships were characterized by just 1 parameter: their area under the curve.

Functional Removal of the Endothelium

In all experiments, except the series testing the effect of acetylcholine and carbachol, the endothelium of the vessels was removed by mechanical disruption using a rat whisker. Functional removal of the endothelium was considered successful when acetylcholine-induced vasodilation was absent during the viability test.

Experimental Protocol

Most experiments were performed using a standardized protocol (Figure S1). Each vessel was assigned to a particular experimental group: either the control group or 1 of the treatment groups (eg, iberiotoxin, SNP, and iberiotoxin+SNP; all experimental groups belonging to a particular experimental series are thus determined by the corresponding figure legend). After the viability test, all vessels were challenged with increasing concentrations of methoxamine in the range from 10^{-8} to 10^{-5} mol/L applied cumulatively in half-log steps for predefined durations. Reliable comparisons of vessel responses between groups required that the vessels in these groups possess the same average initial contractility. Therefore, the average concentration-response relationships to methoxamine obtained directly after the viability test had to be similar (Figure S1A). This was routinely tested in all experimental series. In many experimental groups, vessels were pretreated with the BK channel inhibitor iberiotoxin after methoxamine washout. If this was the case, distilled water, which is the solvent of iberiotoxin, was applied to a control group at the same time. Afterwards, concentration-response relationships to methoxamine were obtained again. Reliable comparisons of vessel responses between groups required that all vessels exposed to iberiotoxin possess the

same average contractility. Therefore, in this case, the average concentration-response relationships to methoxamine of the iberiotoxin groups also had to be similar (Figure S1B). The same requirements were applied to all vessels exposed to the solvent (Figure S1B). This was routinely tested in all experimental series. Finally, after the washout of all drugs applied, the substances to be studied (eg, SNP) were added to the respective experimental groups, and treatments (eg, iberiotoxin) were repeated. Then, concentration-response relationships to methoxamine were obtained again. The latter were used to evaluate the effects studied and are presented in the figures. With this protocol, only data obtained at the same time point during the experiment are compared. Thus, time control experiments were not required. Only NO donors showing a stable relaxation over the time course of the experiment were used (Figure S2).

The standardized protocol was not followed in experiments in which the intracellular calcium concentration ($[Ca^{2+}]_i$) was measured. These protocols are described either in the following section or, because of their specific nature, as an introduction to the corresponding results.

Determination of $[Ca^{2+}]_i$

Isolated vessels were mounted and a viability test performed, as described in Isometric Mounting of Vessels, but in a 1-chamber wire myograph (model 410A; Danish Myotechnology, Denmark). After the viability test, vessels were loaded with 5 μ mol/L FURA 2-AM at 37°C for 90 minutes. During measurements, the dye was excited with light at 340 and 380 nm with use of a filter wheel and a xenon arc lamp. The emission from the vessel was filtered at 520 nm with a long-pass filter, detected by a photomultiplier, and sent to a computer. There, the ratio of emission at the 2 excitation wavelengths after subtraction of the background fluorescence at the respective excitation wavelength was calculated (F340/F380). Background fluorescence was determined from the mounted vessel just before FURA 2 loading. The F340/F380 ratio was used as a measure for the $[Ca^{2+}]_i$. Calibration of the ratio in terms of absolute calcium concentrations was not performed because of the numerous uncertainties related to the binding properties of FURA 2 with $[Ca^{2+}]_i$ in intact vessel preparations. All data were normalized to the F340/F380 ratio developed in response to 10^{-5} mol/L methoxamine, applied after the viability test.

The loading state of the $[Ca^{2+}]_i$ stores was determined by bathing vessels in a solution containing 3×10^{-3} mol/L EGTA to eliminate calcium influx from the extracellular space and by adding the pore-forming agent ionomycin at 10^{-5} mol/L. At this concentration, ionomycin is known to permeabilize membranes to calcium ions. This has 3 effects: (1) it induces

calcium influx from the extracellular space, (2) it evokes calcium release from intracellular stores and empties the latter, and (3) it renders calcium pumps and transporters ineffective.²³

Drugs and Chemicals

Acetylcholine, β -cyano-L-alanine, caffeine, carbachol, diethylenetriamine/NO, hydroxycobalamin, ionomycin, methoxamine, rhodanese, sodium cyanide, SNP, and sodium thiosulfate were obtained from Sigma. S-nitroso-N-acetylpenicillamine and the salts for the solutions were from Merck. Barium chloride was from Riedel de Haen. Iberiotoxin and stromatotoxin were purchased from Alomone Labs. Cyclopiazonic acid, diphenyl phosphine oxide-1, glibenclamide, nimodipine, 1H-[1,2,4]oxadiazolo[4,3-a]quinoxalin-1-one, ryanodine, and XE991 were obtained from Tocris (UK). Rp-8-Br-PET-cGMPS was purchased from Biolog, NG-nitro-L-arginine was purchased from Alexis, and FURA 2-AM was purchased from Life Technologies.

Statistical Analysis

All values are given as mean \pm SEM. N is the number of animals tested. Statistical analysis was performed using GraphPadPrism 6.0. The statistical method used is provided in the figure legends for each particular analysis. Independent-sample *t* test, paired-sample *t* test, repeated-measures ANOVA, and 2-way ANOVA were used. For ANOVA, the interaction and/or the effect of the specific treatment was analyzed. The data of the methoxamine concentration-response relationships were obtained during cumulative addition of methoxamine. They are, thus, interdependent. To avoid this issue during statistical analysis, these relationships were represented by a single parameter: their area under the curve. $P < 0.05$ was considered statistically significant.

Results

Contribution of the BK Channel to the Anticontractile Effect of NO

To study the anticontractile effect of NO, vasoconstrictor-induced vessel responses were investigated in the absence and presence of the NO donor, SNP. Vasoconstriction of rat tail arteries was evoked by the selective α 1-adrenoceptor agonist, methoxamine.²⁴ Methoxamine produced a concentration-dependent contraction (Figure 1A, CONTROL). In the presence of SNP, the methoxamine concentration-response relationship was shifted to the right compared with the control, demonstrating the anticontractile effect of SNP

(Figure 1A). The methoxamine concentration-response relationships were compared by their area under the curve (for details, see Methods). Accordingly, the anticontractile effect of SNP was quantified as the area between the methoxamine-induced concentration-response relationships obtained in the absence and in the presence of SNP (Figure 1C). This analysis showed that SNP produced a concentration-dependent shift of the methoxamine concentration-response relationship to the right (Figure 1D, CONTROL).

To study the contribution of the BK channel to the anticontractile effect of SNP, the BK channel blocker iberiotoxin was used at a saturating concentration,²⁵ used in the vast majority of studies on BK channels. In the presence of iberiotoxin, the SNP-induced shift to the right of the methoxamine concentration-response relationship was also observed (Figure 1B). However, in contrast to expectation, the anticontractile effect of SNP was greater when the BK channel was blocked compared with when it was not blocked (Figure 1D). More important, this unexpected finding was reproduced by other NO donors, like S-nitroso-N-acetylpenicillamine (Figure S3A) and diethylenetriamine-NO (Figure S3B). Because of a much lower rate of NO release, diethylenetriamine-NO had to be used at higher concentrations compared with the other NO donors.²⁶ The new finding was also reproduced with acetylcholine (Figure S3C) and its more stable analog, carbachol (Figure S3D). As expected, the effect of the latter was mediated by NO released from the endothelium, because its effect was blocked completely by the endothelial NO synthase inhibitor NG-nitro-L-arginine (Figure S3D). A major contribution of NO to acetylcholine-induced vasodilation has previously been shown for the vessel studied.^{27,28}

To examine the contribution of the BK channel to the anticontractile effect of SNP in more detail, the functional availability of the BK channel was determined by comparing methoxamine-induced contractions in the absence and presence of iberiotoxin. When methoxamine-induced contractions in the absence and presence of iberiotoxin were indistinguishable and, therefore, BK channels were not able to affect the methoxamine-induced response, we considered BK channels to be functionally unavailable. However, when methoxamine-induced contractions in the absence and presence of iberiotoxin were different and BK channels affected the methoxamine-induced vessel response, we considered BK channels to be functionally available. Our data showed that methoxamine-induced contractions in the presence of iberiotoxin were larger than in the absence of iberiotoxin. The functional availability of the BK channel was quantified as the area between the methoxamine-induced concentration-response relationships obtained in the absence and in the presence of iberiotoxin (Figure 2C). In the presence of SNP,

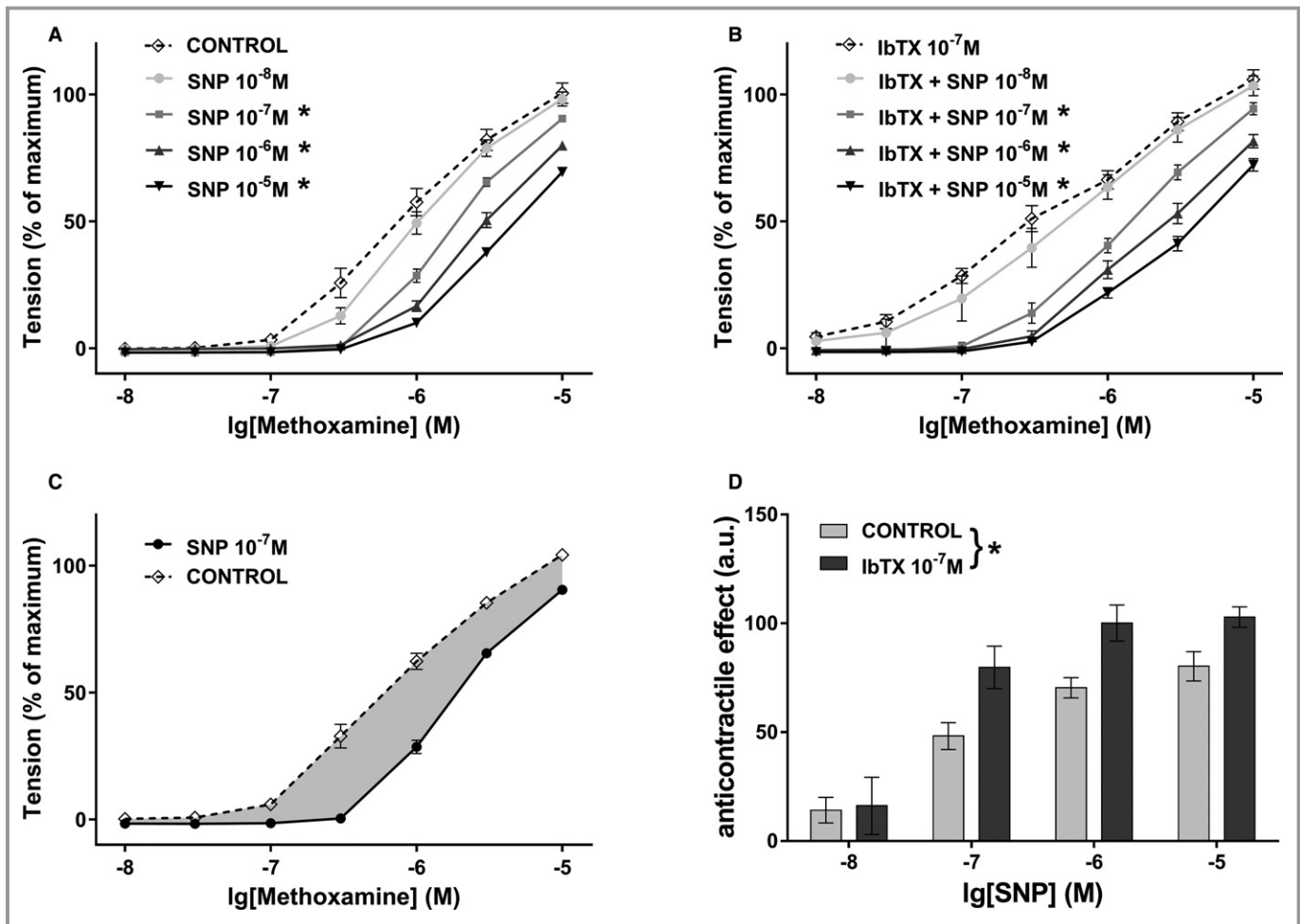

Figure 1. The BK channel blocker iberiotoxin (IbTX) increases the anticontractile effect of sodium nitroprusside (SNP). A, Effect of SNP on methoxamine (MX)-induced contractions. Vessel tension in the absence (CONTROL) and presence of increasing concentrations of SNP (SNP) (repeated-measures ANOVA: $n=6$, $P=0.23$ for SNP 10^{-8} mol/L; $*n=9$, $P<0.001$; $n=7$, $P<0.001$; $n=7$, $P<0.001$ for SNP 10^{-7} , 10^{-6} , and 10^{-5} mol/L, respectively). B, Effect of SNP on MX-induced contractions in the presence of IbTX. Vessel tension in the absence (IbTX) and presence of increasing concentrations of SNP (IbTX+SNP) (repeated-measures ANOVA: $n=6$, $P=0.40$ for SNP 10^{-8} mol/L; $*n=9$, $P<0.001$; $n=7$, $P<0.001$; $n=7$, $P<0.001$ for SNP 10^{-7} , 10^{-6} , and 10^{-5} mol/L, respectively). C, The anticontractile effect of SNP represented as the area (marked in gray) between the MX-induced concentration-response relationships obtained in the absence (CONTROL) and in the presence of SNP (SNP). D, The anticontractile effect of SNP, quantified as described in C, in the absence (CONTROL) and presence of IbTX (2-way ANOVA for effect of SNP: $P<0.001$; $*2$ -way ANOVA control vs IbTX: $P<0.001$; post hoc analysis: $n=9$, $P<0.01$; $n=7$, $P<0.05$; $n=7$, $P<0.05$ for SNP 10^{-7} , 10^{-6} , and 10^{-5} mol/L, respectively).

the functional availability of the BK channel was decreased at several SNP concentrations (Figure 2A, 2B, and 2D). This finding was reproduced by other NO donors, like S-nitroso-N-acetylpenicillamine (Figure S4A) and diethylenetriamine-NO (Figure S4B), as well as by acetylcholine (Figure S4C) and its more stable analog, carbachol (Figure S4D).

More important, similar effects were observed in the saphenous artery of the rat: a greater anticontractile effect of SNP in the presence of iberiotoxin (Figure S5A through S5C) and a decreased functional availability of the BK channel in the presence of SNP (Figure S5A, S5B, and S5D).

Moreover, similar effects were also observed in mouse tail arteries: a greater anticontractile effect of SNP in the

presence of iberiotoxin (Figure S6A through S6C) and a decreased functional availability of the BK channel in the presence of SNP (Figure S6A, S6B, and S6D).

Involvement of NO in the Anticontractile Effect of SNP

It has previously been reported that SNP can release cyanide along with NO when in contact with vessel tissue.²⁹ Therefore, it was clarified whether NO or cyanide mediates the effects of SNP previously described.

First, in the presence of the NO scavenger hydroxycobalamin³⁰ at 10^{-3} mol/L, the anticontractile effect of SNP was abolished

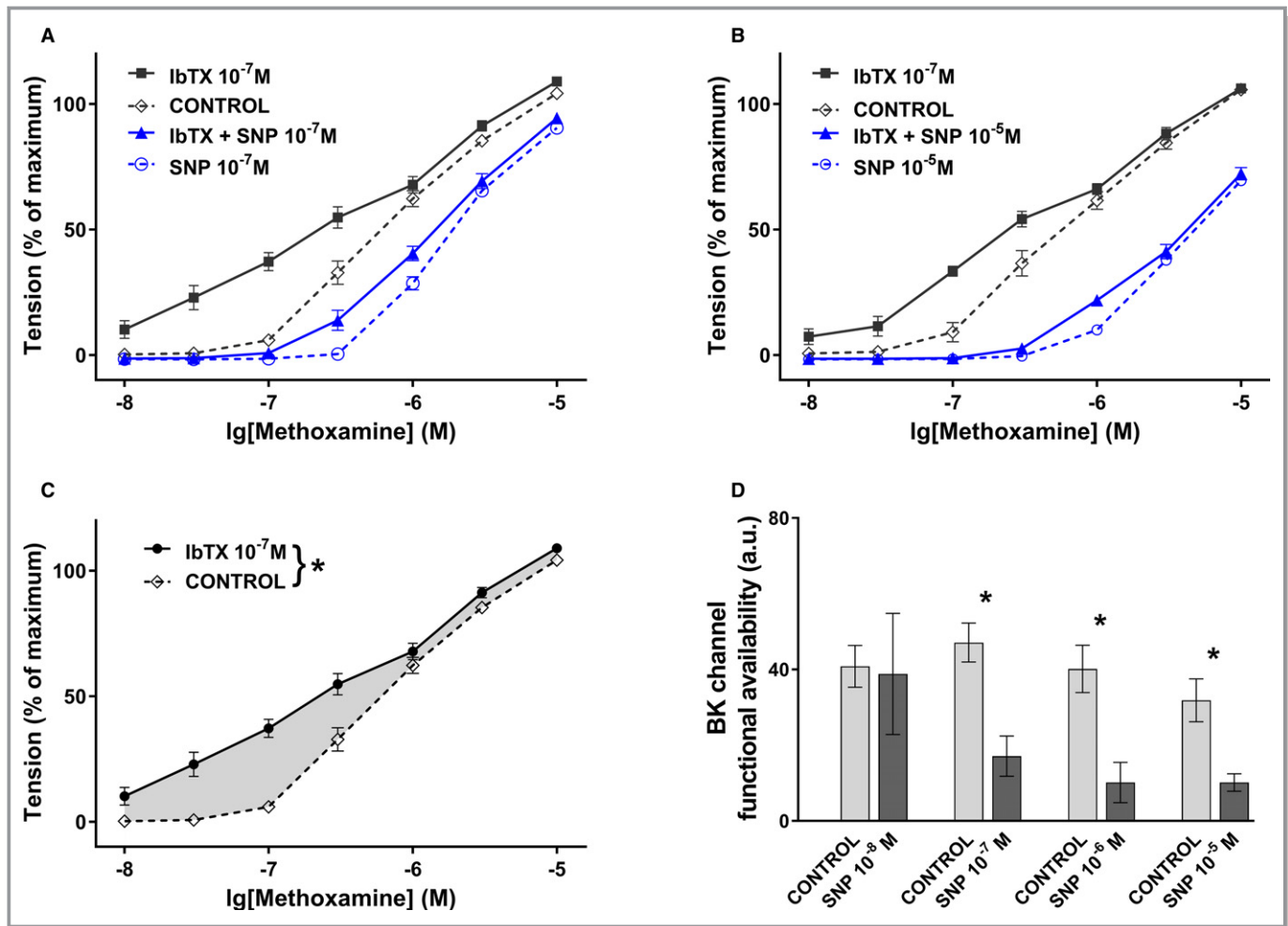

Figure 2. Sodium nitroprusside (SNP) decreases the functional availability of the BK channel. Effect of SNP and iberiotoxin (IbTX) on methoxamine (MX)–induced contractions. Vessel tension in the absence of IbTX and SNP (CONTROL), in the presence of IbTX alone (IbTX), in the presence of SNP alone (SNP), and in the combined presence of IbTX and SNP (IbTX+SNP) at, for example, 10^{-7} mol/L (A) and 10^{-5} mol/L (B) SNP. C, The functional availability of the BK channel represented as the area (marked in gray) between the MX-induced concentration–response relationships obtained in the absence (CONTROL) and in the presence of IbTX (IbTX) (*repeated-measures ANOVA: $n=9$; $P<0.001$). D, Functional availability of the BK channel, quantified as described in C, in the absence (CONTROL) and presence of SNP (SNP) (t test: $n=6$, $P=0.91$; * $n=9$, $P<0.001$; $n=7$, $P<0.01$; $n=7$, $P<0.01$ for SNP 10^{-8} , 10^{-7} , 10^{-6} , and 10^{-5} mol/L, respectively).

(Figure S7A and S7B), including its effect on the BK channel (Figure S7A and S7C).

Second, pretreatment of vessels with 30 U/L rhodanese and 1.25×10^{-4} mol/L sodium thiosulfate,³¹ which inactivate cyanide by transferring the sulfane sulfur from thiosulfate to cyanide to form thiocyanide and sulphite,³² did not alter the anticontractile effect of SNP (Figure S8A and S8B) or its effect on the BK channel (Figure S8A and S8C).

Third, cyanide itself did not show an anticontractile effect (Figure S9A and S9B), nor did it influence BK channel functional availability (Figure S9A and S9C).

Finally, it has been reported that SNP can directly interact with H_2S , leading to the generation of nitroxyl, and that the latter could be responsible for the observed functional effects.³³ Pretreatment of vessels with 3×10^{-3} mol/L β -

cyano-L-alanine, an inhibitor³⁴ of the major H_2S -generating enzymes cystathionine γ -lyase and cystathionine β -synthase in vascular tissue,³⁵ somewhat reduced the anticontractile effect of SNP (Figure S10A and S10B). Yet, in the presence β -cyano-L-alanine, the anticontractile effect of SNP was greater when the BK channel was blocked, compared with when it was not blocked (Figure S10B), and functional availability of the BK channel was decreased in the presence of SNP (Figure S10C).

Guanylyl Cyclase and PKG Pathway in the Anticontractile Effect of SNP

It has previously been reported that SNP induces an increase of cGMP.³⁶ This suggests that SNP activates the guanylyl cyclase/PKG pathway. Application of the selective guanylyl

cyclase blocker 1H-[1,2,4]oxadiazolo[4,3-a]quinoxalin-1-one³⁷ at 10^{-6} mol/L abolished the anticontractile effect of SNP (Figure 3A and 3B) and its effect on the BK channel completely (Figure 3A and 3C). In the presence of 10^{-5} mol/L Rp-8-Br-PET-cGMPS, a selective PKG inhibitor,³⁸ the anticontractile effect of SNP (Figure 3D and 3E) and its effect on the BK channel (Figure 3D and 3F) were reduced.

Involvement of Changes in the $[Ca^{2+}]_i$ in the Anticontractile Effect of SNP

Because the $[Ca^{2+}]_i$ is a major regulator of BK channel activity, the effect of SNP on $[Ca^{2+}]_i$ was studied.

In the presence of SNP, the methoxamine concentration-response relationship for $[Ca^{2+}]_i$ was shifted to the right,

compared with the control (Figure 4A), similar to the effect of SNP on methoxamine-induced tension (as previously described).

In the presence of iberiotoxin, the SNP-induced shift to the right of the methoxamine concentration-response relationship for $[Ca^{2+}]_i$ was also observed (Figure 4B). The effects of SNP on $[Ca^{2+}]_i$ were greater when the BK channel was blocked, compared with when it was not blocked.

Involvement of Changes in Calcium Release and Calcium Influx in the Anticontractile Effect of SNP

The attenuation of the methoxamine-induced increase in $[Ca^{2+}]_i$ by SNP may result from an interference of SNP with the methoxamine-evoked release of calcium from intracellular stores mediated by ryanodine receptors and/or IP₃ receptors.

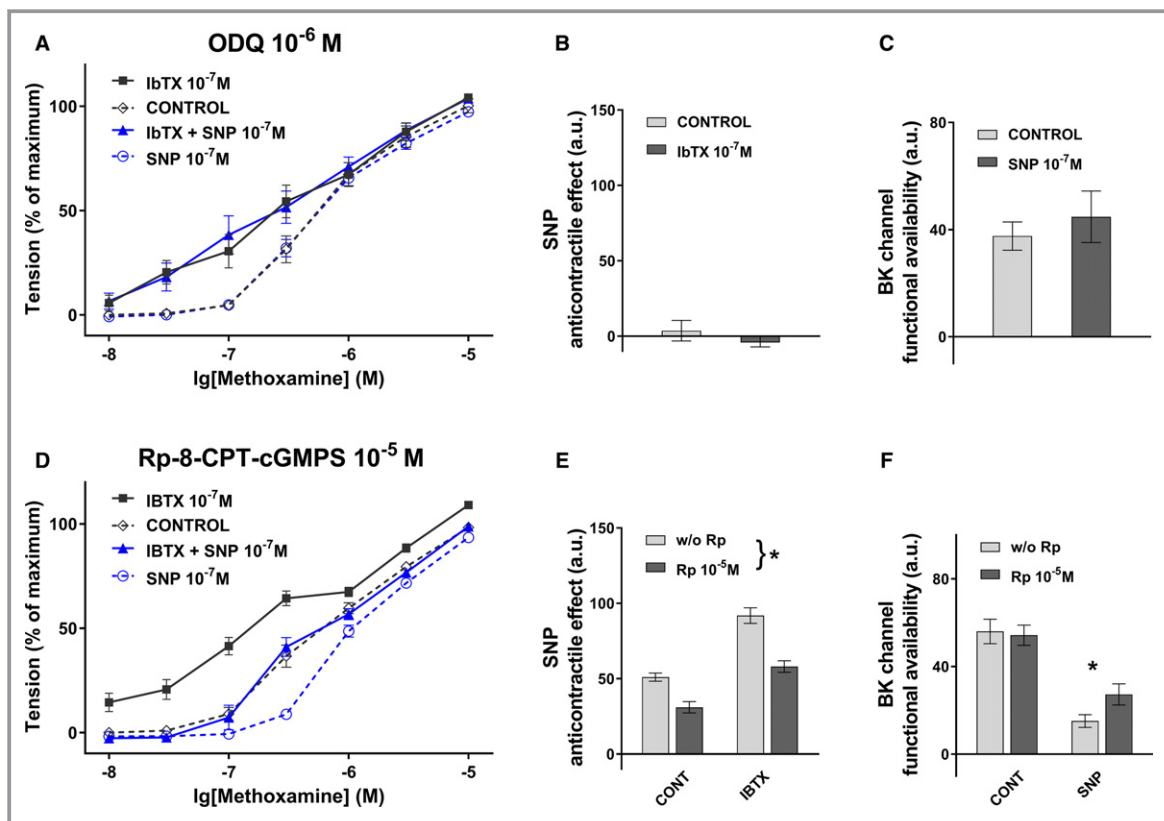

Figure 3. Effect of the guanylyl cyclase inhibitor 1H-[1,2,4]oxadiazolo[4,3-a]quinoxalin-1-one (ODQ) and the protein kinase G inhibitor Rp-8-Br-PET-cGMPS (Rp) on the anticontractile effect of sodium nitroprusside (SNP). A, Effect of SNP and iberiotoxin (IbTX) on methoxamine (MX)-induced contractions in the presence of ODQ (10^{-6} mol/L). Vessel tension in the absence of IbTX and SNP (CONTROL), in the presence of IbTX alone (IbTX), in the presence of SNP alone (SNP), and in the combined presence of IbTX and SNP (IbTX+SNP) at 10^{-7} mol/L SNP (repeated-measures ANOVA: $n=5$, $P=0.71$ for CONTROL vs SNP and $n=5$, $P=0.85$ for IbTX vs IbTX+SNP). B, The anticontractile effect of SNP in the absence (CONTROL) and presence of IbTX (t test: $n=5$, $P=0.38$). C, Functional availability of the BK channel in the absence (CONTROL) and presence of SNP (SNP) (t test: $n=5$, $P=0.53$). D, Effect of SNP and IbTX on MX-induced contractions in the presence of 10^{-5} mol/L Rp. Vessel tension in the absence of IbTX and SNP (CONTROL), in the presence of IbTX alone (IbTX), in the presence of SNP alone (SNP), and in the combined presence of IbTX and SNP (IbTX+SNP) at 10^{-7} mol/L SNP (repeated-measures ANOVA: $n=8$, $P<0.01$ for CONTROL vs SNP and $n=8$, $P<0.001$ for IbTX vs IbTX+SNP). E, The anticontractile effect of SNP in the absence (CONT) and presence of IbTX (*2-way ANOVA without [w/o] vs with Rp: $n=8$, $P<0.001$; t test CONT vs IbTX: w/o Rp $n=8$; $P<0.001$; with Rp $n=8$; $P<0.001$). F, Functional availability of the BK channel in the absence (CONT) and presence of SNP (SNP) (* t test w/o vs with Rp: $n=8$; $P<0.05$; t test CONT vs SNP: w/o Rp $n=8$; $P<0.001$; with Rp $n=8$; $P<0.01$).

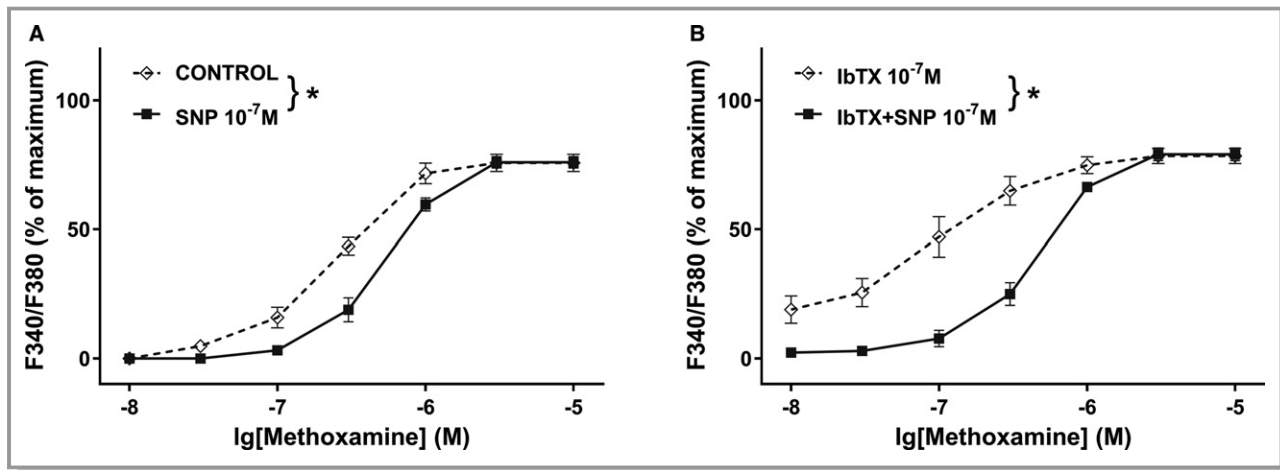

Figure 4. The BK channel blocker IBTX increases the effect of SNP on intracellular calcium. A) Effect of SNP on MX-induced $[Ca^{2+}]_i$ increase. F340/F380 ratio, a measure for the intracellular calcium concentration, in the absence (CONTROL) and presence of SNP (SNP 10^{-7} M) (* - repeated measures ANOVA: $n=5$, $P<0.05$). B) Effect of SNP on MX-induced $[Ca^{2+}]_i$ increase in the presence of IbTX. F340/F380 ratio in the absence (IbTX) and presence of SNP (IbTX+SNP 10^{-7} M) (* - repeated measures ANOVA: $n=8$, $P<0.001$). The effect of SNP on MX-induced $[Ca^{2+}]_i$ increases was larger in the presence of IbTX compared to its absence (t -test: $n=5,8$; $P<0.05$).

However, the increase in $[Ca^{2+}]_i$ produced by 10^{-2} mol/L caffeine, a widely used and selective activator of ryanodine receptors, was not altered by SNP (Figure 5A). Furthermore, when calcium influx was eliminated by adding 3×10^{-3} mol/L of the calcium chelator EGTA to the extracellular solution shortly before application of methoxamine, the increase in $[Ca^{2+}]_i$ induced by 10^{-5} mol/L methoxamine was not affected by SNP (Figure 5B). Moreover, $[Ca^{2+}]_i$ store content was estimated by applying the calcium-ionophore ionomycin in the presence of EGTA in the extracellular solution (for more detail, see Methods).²³ The increase in $[Ca^{2+}]_i$ produced by 10^{-5} mol/L ionomycin was also not altered by SNP (Figure 5C). In contrast, when calcium release was eliminated by pretreating vessels with the widely used sarco/endoplasmic reticulum Ca^{2+} -ATPase inhibitor, cyclopiazonic acid, at 10^{-5} mol/L and the ryanodine receptor blocker, ryanodine, at 10^{-5} mol/L to leave only calcium influx, the methoxamine-induced increase in $[Ca^{2+}]_i$ was shifted to the right in the presence of SNP (Figure 5D). Notably, under these conditions, the methoxamine-induced increase in $[Ca^{2+}]_i$ was prevented completely by vessel pretreatment with 10^{-6} mol/L nimodipine, an established blocker of L-type voltage-dependent calcium channels (VOCs) (Figure 5D).

Involvement of Changes in Calcium Influx in the Anticontractile Effect of SNP

The reduction of calcium influx via VOCs by SNP may result from an SNP-induced opening of non-BK potassium channels,³⁹ leading to cell membrane hyperpolarization and a subsequent closure of VOCs. However, when most non-BK potassium channels known to be expressed in vascular

smooth muscle were inhibited by a blocker mixture (which contained the Kv1 channel blocker diphenyl phosphine oxide-1 at 10^{-6} mol/L,⁴⁰ the Kv2 channel blocker stromatoxin at 10^{-7} mol/L,⁴¹ the Kv7 channel blocker XE991 at 3×10^{-6} mol/L,⁴² the Kir2 channel blocker barium chloride at 3×10^{-5} mol/L,⁴³ and the Kir6 channel blocker glibenclamide at 10^{-6} mol/L⁴⁴), a greater anticontractile effect of SNP in the presence of iberiotoxin (Figure S11A and S11B) and a decreased functional availability of the BK channel in the presence of SNP (Figure S11A and S11C) were still observed. When the indirect potassium channel-mediated effects of SNP on VOC were eliminated by either precontracting vessels with 120 mmol/L KCl or applying the previously mentioned blocker mixture, including 10^{-7} mol/L iberiotoxin, SNP produced relaxation (Figure S11D) associated with a decrease in $[Ca^{2+}]_i$ (Figure S11E).

Finally, in tail arteries of BK channel $\beta 1$ -subunit-deficient mice,¹⁷ SNP produced an anticontractile effect (Figure 6A through 6C), but this effect was not augmented anymore in the presence of iberiotoxin (Figure 6A through 6C), and SNP had no effect on the functional availability of the BK channel (Figure 6A, 6B, and 6D).

Discussion

The present study revealed 8 major findings. First, continuously present NO donors (SNP, S-nitroso-N-acetylpenicillamine, and diethylenetriamine-NO), and endogenously produced NO, released in response to acetylcholine and carbachol, evoke an anticontractile effect. Second, these substances produce a greater anticontractile effect in the

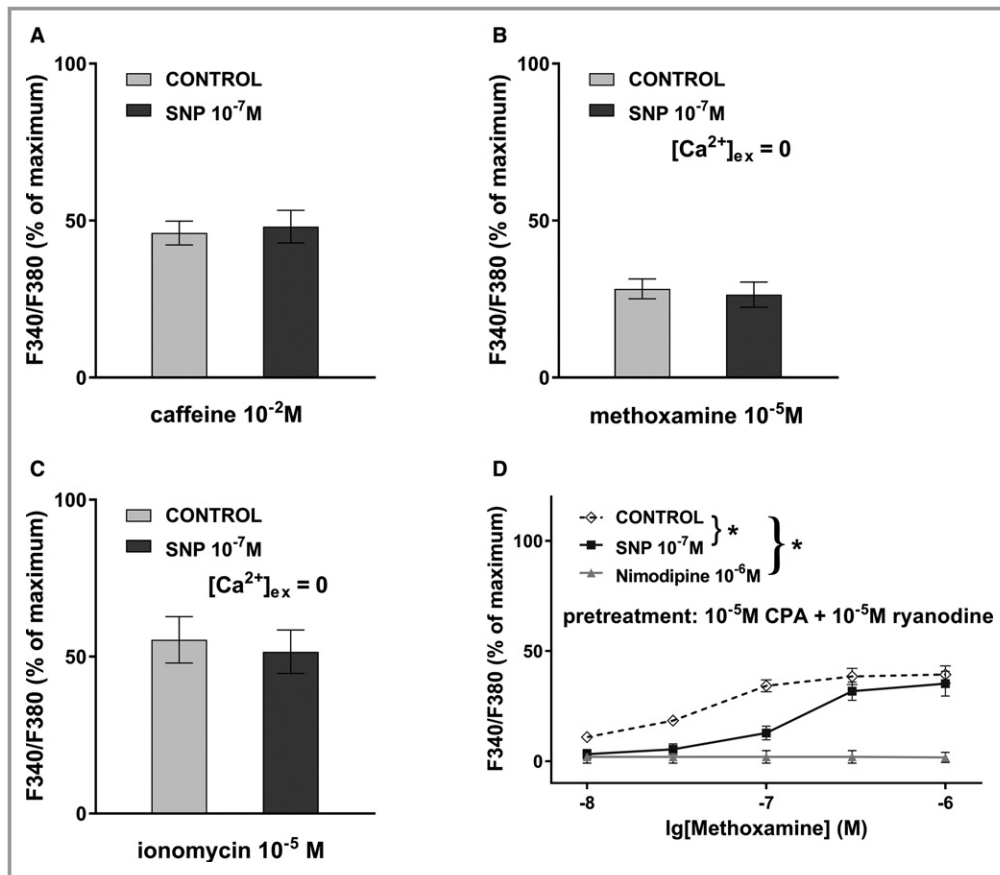

Figure 5. Sodium nitroprusside (SNP) affects intracellular calcium concentration ($[Ca]_i$) by an interaction with calcium influx. A, Effect of SNP on caffeine-induced $[Ca]_i$ increase. F340/F380 ratio in the absence (CONTROL) and presence of SNP (SNP 10^{-7} mol/L) (t test: $n=5$, $P=0.76$). B, Effect of SNP on methoxamine (MX)-induced $[Ca]_i$ increase in calcium-free extracellular solution. F340/F380 ratio in the absence (CONTROL) and presence of SNP (SNP 10^{-7} mol/L) (t test: $n=5$, $P=0.73$). C, Effect of SNP on ionomycin-induced $[Ca]_i$ increase in calcium-free extracellular solution. F340/F380 ratio in the absence (CONTROL) and presence of SNP (SNP 10^{-7} mol/L) (t test: $n=5$, $P=0.71$). D, Effect of SNP or nimodipine on MX-induced $[Ca]_i$ increase in the presence of 10^{-5} mol/L cyclopiazonic acid (CPA) and 10^{-5} mol/L ryanodine. F340/F380 ratio in the absence (CONTROL) and presence of SNP (SNP 10^{-7} mol/L) or nimodipine (10^{-6} mol/L) (*repeated-measures ANOVA: $n=6$, $P<0.001$ and $n=5$, $P<0.001$, respectively).

presence of iberiotoxin, and decrease the functional availability of the BK channel. Third, these 2 effects occur in several arteries from rats and mice. Fourth, the observed effects of SNP were not mimicked by cyanide and not altered by rhodanese together with sodium thiosulfate, nor by β -cyano-L-alanine. Fifth, the effects were abolished by hydroxycobalamin and by 1H-[1,2,4]oxadiazolo[4,3-a]quinoxalin-1-one, and reduced considerably by Rp-8-Br-PET-cGMPs. Sixth, SNP reduced the $[Ca^{2+}]_i$ response to methoxamine in vascular smooth muscle cells. Seventh, SNP did not alter the $[Ca^{2+}]_i$ response to caffeine and to methoxamine and ionomycin in calcium-free extracellular solution. Eighth, SNP reduced the $[Ca^{2+}]_i$ response to methoxamine when calcium release was eliminated: a response depending entirely on VOCs.

Anticontractile Effect of NO Donors Is Mediated by NO

NO is a gas that is difficult to handle. Therefore, in almost all experimental studies, as well as in clinical practice,^{45,46} NO donors are used. However, NO donors may evoke their effects, at least partly, independently of NO.^{45,46} Yet, this seems not to be the case in the present study.

First, 3 different NO donors, SNP, S-nitroso-N-acetylpenicillamine, and diethylenetriamine-NO, possessing different properties, except the ability to release NO, produced identical effects. Moreover, the same effects were evoked by acetylcholine and carbachol, known to release endogenous NO from vascular endothelium.^{27,28} This was also observed in the present study, where their effects were blocked by NG-

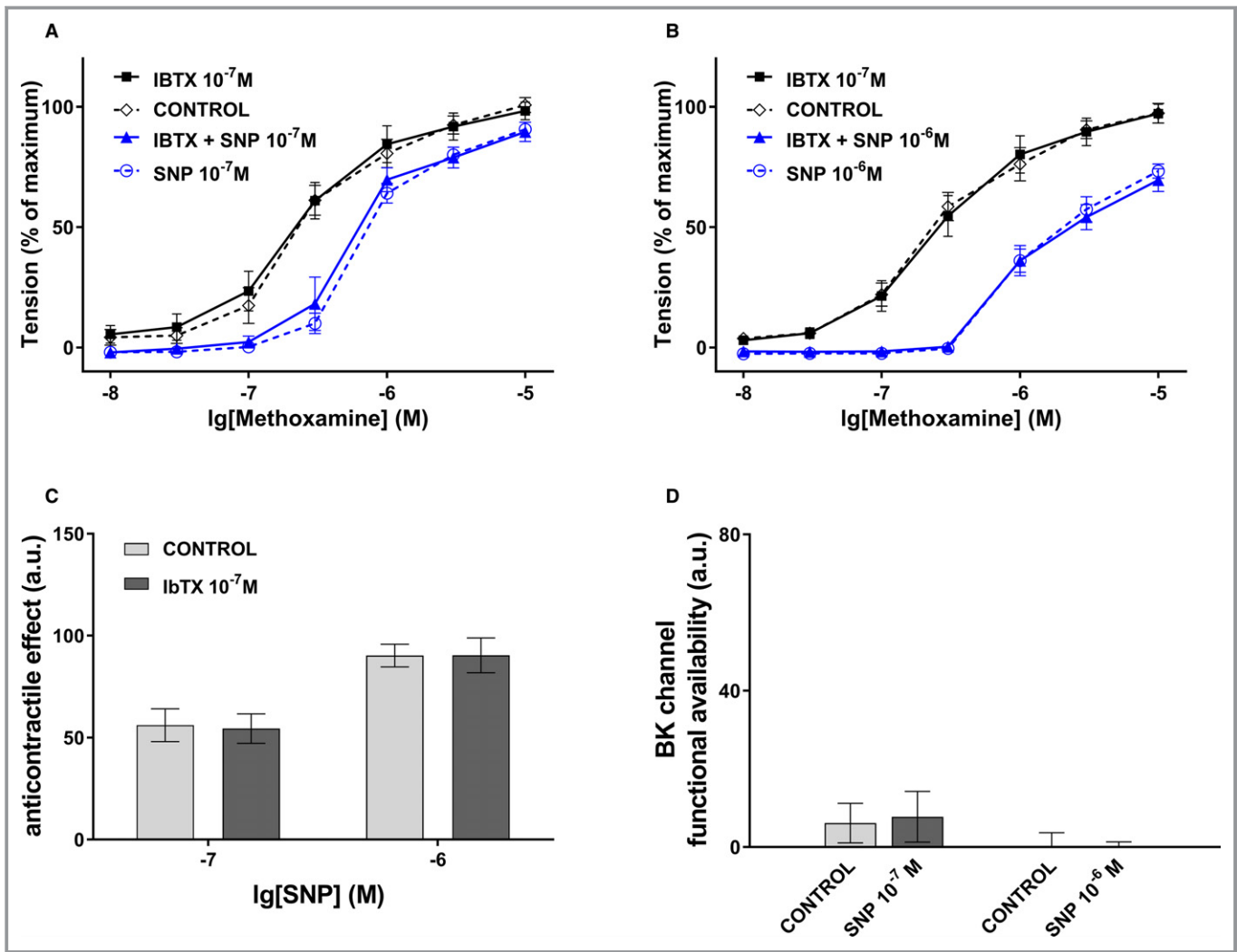

Figure 6. Contribution of the BK channel to the anticontractile effect of sodium nitroprusside (SNP) in tail arteries of $\beta 1$ -deficient mice. Effect of SNP and iberitoxin (IbTX) on methoxamine-induced contractions. Vessel tension in the absence of IbTX and SNP (CONTROL), in the presence of IbTX alone (IbTX), in the presence of SNP alone (SNP), and in the combined presence of IbTX and SNP (IbTX+SNP) at 10^{-7} mol/L (A) and 10^{-6} mol/L (B) SNP. C, The anticontractile effect of SNP in the absence (CONTROL) and presence of IbTX (2-way ANOVA for effect of SNP: $n=8$; $P<0.001$; 2-way ANOVA control vs IbTX: $n=8$; $P=0.92$). D, Functional availability of the BK channel in the absence (CONTROL) and presence of SNP (SNP) (t test: $n=8$, $P=0.85$ and $n=8$, $P=0.98$ for SNP 10^{-7} and 10^{-6} mol/L, respectively).

nitro-L-arginine, an established endothelial NO synthase inhibitor.

Second, the presented data show that the effects of the most often used NO donor in this study (SNP) were abolished by hydroxycobalamin, an NO scavenger.³⁰ Also, its effects were not mimicked by cyanide, previously reported to be released from SNP along with NO.²⁹ Furthermore, the effects were not affected by rhodanese and sodium thiosulfate,³¹ which inactivate cyanide.³² Finally, the effects of SNP were also unaltered by β -cyano-L-alanine, an inhibitor³⁴ of cystathionine γ -lyase and cystathionine β -synthase, the major H₂S-producing enzymes in vascular tissue.³⁵ H₂S has been reported to interact directly with SNP, leading to the

generation of nitroxyl responsible for the functional observed effects.³³

Third, in line with the established opinion that the vasodilatory effect of NO is mediated by the soluble guanylyl cyclase/PKG signaling pathway,^{3,4} the effects of SNP observed in the present study were as follows: (1) abolished by the selective soluble guanylyl cyclase blocker 1H-[1,2,4]oxadiazolo[4,3-a]quinoxalin-1-one³⁷ and (2) reduced by the selective PKG inhibitor, Rp-8-Br-PET-cGMPS.³⁸ Rp-8-Br-PET-cGMPS at concentrations higher than the one used in the present study may stimulate basal PKG activity.^{47,48} Consequently, such Rp-8-Br-PET-cGMPS concentrations were not used, even if they may be required for the complete inhibition of PKG.^{47,48}

In conclusion, several lines of evidence provided in the present study strongly suggest that the effects observed using NO donors are induced by NO.

BK Channel Limits the Anticontractile Effect of NO

The data of the present study show that NO produces a concentration-dependent shift of the methoxamine concentration-response relationship to the right, which equals an anticontractile effect. Many previous investigations reported that NO produces vasodilation.³ This strongly supports our findings demonstrating an anticontractile effect of NO.

However, our observations about the contribution of the BK channel to the anticontractile effect of NO were completely unexpected. Previously, a substantial number of studies provided evidence that BK channels mediate NO-induced vasodilation^{8–11} (additional studies listed and discussed by Tanaka et al¹²). A few studies reported that BK channels do not contribute to NO-induced vasodilation.^{13–16} The data of the present study show that the anticontractile effect of NO was greater when the BK channel was blocked. In addition, we observed that the functional availability of the BK channel was decreased in the presence of NO. Most important, these findings were observed on 2 different vessel preparations in 2 species, the rat and the mouse. Thus, the data of the present study suggest the new alternative idea that BK channels can limit the anticontractile effect of NO.

An alternative analysis of the data provided more insight. This analysis showed that the SNP-induced relaxation is smaller in the presence of iberiotoxin (Figure S12), suggesting that BK channels facilitate NO-induced vasodilation. There is an important limitation with this alternative approach. With this approach, the effect of NO is studied on the basis of a single initial contractile state at a high contraction level. There, NO produced only a small decrease in $[Ca^{2+}]_i$ (Figure 4B at 10^{-6} mol/L methoxamine). In contrast, in the present study, vessels were contracted from full relaxation to maximal contraction, and the effect of NO was investigated on the basis of the full range of vessel contractility. There, NO generated a considerable decrease in $[Ca^{2+}]_i$ (Figure 4B). Thus, the difference in the effect of NO on $[Ca^{2+}]_i$ may be the reason for obtaining 2 contradictory conclusions.

The latter idea is emphasized by the following mechanistic considerations. At a high contraction level, NO induces a PKG-mediated increase in BK channel activity, well established by many studies,^{1,5,6} that is stronger than the small $[Ca^{2+}]_i$ decrease-mediated decrease of BK channel activity. The overall effect of both is an activation of the BK channel, consistent with the conclusion reached with the alternative approach that BK channels facilitate NO-induced vasodilation (Figure 7A). With the approach of the present study,

especially at lower levels of contractility, NO induces a PKG-mediated increase in BK channel activity that is weaker than the large $[Ca^{2+}]_i$ decrease-mediated decrease in BK channel activity. The overall effect of both is a reduction of BK channel activity, consistent with the conclusion reached in this study: that BK channels limit the anticontractile effect of NO (Figure 7B). Thus, the effect of NO on the BK channel seems to be mediated by a signaling pathway consisting of 2 simultaneously activated branches: 1 increasing and 1 decreasing BK channel activity, where a decrease in channel activity prevails when the full range of vessel contractility is considered. Because a high contraction level was used in most previous studies, the role of a decrease in $[Ca^{2+}]_i$ for BK channel functional availability during NO-induced vasodilation was underestimated. Thus, the existence of opposing conclusions reached in this and in previous studies is not contradictory, but rather reflects a common mechanism explored at different conditions as related to the level of precontraction used.

In conclusion, the data of the present study promote the new idea that the BK channel limits the anticontractile effect of NO, especially at lower levels of contractility, where NO induces a strong decrease of $[Ca^{2+}]_i$ (Figure 7B). Only at high contraction levels, where NO induces a small decrease of $[Ca^{2+}]_i$, does the BK channel facilitate NO-induced vasodilation (Figure 7A).

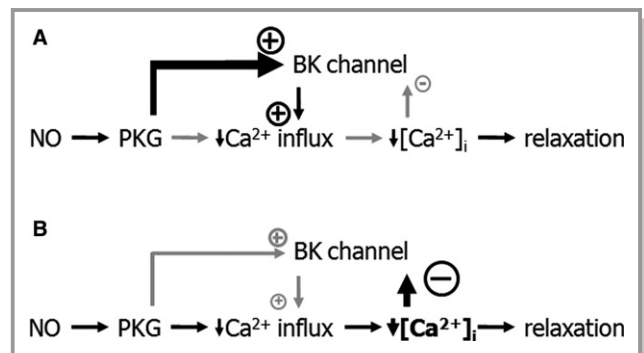

Figure 7. Schematic representation of the mechanism of BK channel contribution to the anticontractile effect of sodium nitroprusside. A, Conditions when NO produced only a small decrease in intracellular calcium concentration ($[Ca^{2+}]_i$): NO induces a protein kinase G (PKG)-mediated activation of the BK channel that is stronger than the small $[Ca^{2+}]_i$ decrease-mediated deactivation of the BK channel. The overall effect of both is an activation of the BK channel contributing to the reduction of calcium influx; BK channels facilitate NO-induced vasodilation. B, Conditions when NO produced a considerable decrease in $[Ca^{2+}]_i$: NO induces a PKG-mediated activation of the BK channel that is weaker than the large $[Ca^{2+}]_i$ decrease-mediated deactivation of the BK channel. The overall effect of both is a deactivation of the BK channel opposing the reduction of calcium influx; BK channels limit NO-induced vasodilation.

Ability of the BK Channel to Limit the Anticontractile Effect of NO Is Caused by an NO-Induced Reduction of Calcium Influx via L-Type Calcium Channels

In the present study, NO reduced the methoxamine-induced increase in $[Ca^{2+}]_i$. This observation is supported by many findings published previously^{49,50} (reviewed by Francis et al⁴). However, an unexpected increase of the effect of NO on $[Ca^{2+}]_i$ was observed when BK channels were blocked. This is an important finding. Indeed, if BK channels were to facilitate NO-evoked dilations, as often suggested, the NO-induced activation of BK channels would lead to membrane potential hyperpolarization, a closure of VOCs, and a subsequent decrease of $[Ca^{2+}]_i$. This mechanism would be suppressed in the presence of BK channel blockers like iberiotoxin, reflected by a smaller NO-induced decrease of $[Ca^{2+}]_i$ in the presence of iberiotoxin. More important, just the opposite was observed in the presence of iberiotoxin: a larger decrease of $[Ca^{2+}]_i$ in response to NO was seen. Thus, these data mechanistically support the newly suggested limiting role of the BK channel on NO-induced vasodilation.

In addition, the data of the present study suggest a mechanism by which NO produces the decrease in $[Ca^{2+}]_i$.

First, NO did not affect increases in $[Ca^{2+}]_i$ produced by caffeine. Neither did it affect the increases in $[Ca^{2+}]_i$ caused by methoxamine, when calcium influx was eliminated by adding EGTA to the extracellular solution shortly before application of methoxamine. And NO also did not affect the increases in $[Ca^{2+}]_i$ caused by ionomycin in the presence of EGTA in the extracellular solution, providing an estimate of $[Ca^{2+}]_i$ store content (for more details, see Methods and the study by Fasolato and Pozzan²³). Thus, NO does not seem to interfere with calcium release from and calcium sequestration into $[Ca^{2+}]_i$ stores.

Second, on depleting $[Ca^{2+}]_i$ stores and inhibiting calcium-induced calcium release from these stores by pretreating vessels with cyclopiazonic acid and ryanodine, NO still reduced the increase in $[Ca^{2+}]_i$ produced by methoxamine. Because the methoxamine-induced increase in $[Ca^{2+}]_i$ under these conditions was completely abolished by nimodipine, it can be concluded that this calcium influx was exclusively mediated by VOCs. Thus, NO decreases $[Ca^{2+}]_i$ by a reduction of calcium influx via VOCs, a mechanism discussed previously.⁴

Third, for the reduction of VOC activity by NO, it should be considered that NO could produce this effect indirectly, mediated by cell membrane hyperpolarization in response to an NO-induced opening of non-BK potassium channels, as observed previously.³⁹ However, the anticontractile effect of NO and its action on the functional availability of the BK channel were not altered when most non-BK potassium channels known to be expressed in vascular smooth muscle

were inhibited by a blocker mixture (containing the Kv1 channel blocker diphenyl phosphine oxide-1,⁴⁰ the Kv2 channel blocker stromatoxin,⁴¹ the Kv7 channel blocker XE991,⁴² the Kir2 channel blocker barium chloride,⁴³ and the Kir6 channel blocker glibenclamide⁴⁴). In addition, NO produced considerable decreases in $[Ca^{2+}]_i$ when potassium channels, including BK channels, were either functionally silenced by precontracting vessels with 120 mmol/L KCl or inhibited by the previously mentioned blocker mixture including iberiotoxin. These experimental conditions eliminate indirect potassium channel-mediated effects of NO on VOCs. Thus, NO reduces VOC activity by a mechanism independent of changes in membrane potential in response to an NO-induced activation of non-BK potassium channels. This mechanism most likely involves soluble guanylyl cyclase and PKG, according to the data presented in this study and to previous findings showing a PKG-induced inhibition of L-type VOCs in isolated vascular smooth muscle cells.^{51,52} The details of this mechanism are beyond the focus of the present study and have to be addressed in future studies.

Finally, this study provides another important piece of evidence supporting the idea that an NO-induced reduction of calcium influx via VOC enables the BK channel to limit the anticontractile effect of NO. Namely, in BK channel $\beta 1$ -subunit-deficient mice, in which the BK channel cannot respond to NO-induced reductions of calcium influx because of a considerably decreased calcium sensitivity of the BK channel,¹⁷ the anticontractile effect of NO, and its action on the functional availability of the BK channel were no longer affected by iberiotoxin.

In conclusion, the data of the present study show that an NO-induced reduction of calcium influx via L-type VOCs leads to a decrease of BK channel activity, which limits the anticontractile effect of NO, especially at lower levels of contractility.

This study demonstrates, first, that continuously present NO donors evoke a strong anticontractile effect on rat and mouse arteries, which is induced by NO. Second, it shows that the iberiotoxin-induced augmentation of the anticontractile effect of NO is associated with an NO-induced reduction of the effect of iberiotoxin over almost the whole range of vessel contractility, whereas activation of BK channels facilitates NO-induced vasodilation only at high contraction levels. Finally, it reveals that NO evokes a reduction of calcium influx via L-type calcium channels that may enable the BK channel to limit the anticontractile effect of NO, especially at lower levels of contractility.

Sources of Funding

This study was supported by Deutsche Forschungsgemeinschaft GRK 1874 (SP4 to Schubert) and the German Academic Exchange Service (to Gaynullina).

Disclosures

None.

References

- Schubert R, Nelson MT. Protein kinases: tuners of the BKCa channel in smooth muscle. *Trends Pharmacol Sci*. 2001;22:505–512.
- Alioua A, Mahajan A, Nishimaru K, Zarei MM, Stefani E, Toro L. Coupling of c-Src to large conductance voltage- and Ca²⁺-activated K⁺ channels as a new mechanism of agonist-induced vasoconstriction. *Proc Natl Acad Sci U S A*. 2002;99:14560–14565.
- Zhao Y, Vanhoutte PM, Leung SW. Vascular nitric oxide: beyond eNOS. *J Pharmacol Sci*. 2015;129:83–94.
- Francis SH, Busch JL, Corbin JD, Sibley D. cGMP-dependent protein kinases and cGMP phosphodiesterases in nitric oxide and cGMP action. *Pharmacol Rev*. 2010;62:525–563.
- Alioua A, Huggins JP, Rousseau E. PKG-I alpha phosphorylates the alpha-subunit and upregulates reconstituted GK(Ca) channels from tracheal smooth muscle. *Am J Physiol*. 1995;12:L1057–L1063.
- Kyle BD, Hurst S, Swayze RD, Sheng J, Braun AP. Specific phosphorylation sites underlie the stimulation of a large conductance, Ca²⁺-activated K⁺ channel by cGMP-dependent protein kinase. *FASEB J*. 2013;27:2027–2038.
- Bolotina VM, Najibi S, Palacino JJ, Pagano PJ, Cohen RA. Nitric oxide directly activates calcium-dependent potassium channels in vascular smooth muscle. *Nature*. 1994;368:850–853.
- Robertson BE, Schubert R, Hescheler J, Nelson MT. cGMP-dependent protein kinase activates Ca-activated K-channels in cerebral artery smooth muscle cells. *Am J Physiol*. 1993;265:C299–C303.
- Taniguchi J, Furukawa K, Shigekawa M. Maxi K⁺ channels are stimulated by cyclic guanosine monophosphate-dependent protein kinase in canine coronary artery smooth muscle cells. *Pflügers Arch*. 1993;423:167–172.
- Archer SL, Huang JMC, Hampf V, Nelson DP, Shultz PJ, Weir EK. Nitric oxide and cGMP cause vasorelaxation by activation of a charybdotoxin-sensitive K channel by cGMP-dependent protein kinase. *Proc Natl Acad Sci U S A*. 1994;91:7583–7587.
- Sausbier M, Schubert R, Voigt V, Hirneiss C, Pfeifer A, Korth M, Kleppisch T, Ruth P, Hofmann F. Mechanisms of NO/cGMP-dependent vasorelaxation. *Circ Res*. 2000;87:825–830.
- Tanaka Y, Koike K, Toro L. MaxiK channel roles in blood vessel relaxations induced by endothelium-derived relaxing factors and their molecular mechanisms. *J Smooth Muscle Res*. 2004;40:125–153.
- Bialecki RA, Stinsonfisher C. K-Ca channel antagonists reduce NO donor-mediated relaxation of vascular and tracheal smooth muscle. *Am J Physiol*. 1995;12:L152–L159.
- Murphy ME, Brayden JE. Nitric oxide hyperpolarizes rabbit mesenteric arteries via ATP-sensitive potassium channels. *J Physiol*. 1995;486:47–58.
- Corriu C, Feletou M, Canet E, Vanhoutte PM. Endothelium-derived factors and hyperpolarization of the carotid artery of the guinea-pig. *Br J Pharmacol*. 1996;119:959–964.
- Plane F, Wiley KE, Jeremy JY, Cohen RA, Garland CJ. Evidence that different mechanisms underlie smooth muscle relaxation to nitric oxide and nitric oxide donors in the rabbit isolated carotid artery. *Br J Pharmacol*. 1998;123:135–1358.
- Pluger S, Faulhaber J, Furstenau M, Lohn M, Waldschutz R, Gollasch M, Haller H, Luft FC, Ehmke H, Pongs O. Mice with disrupted BK channel beta1 subunit gene feature abnormal Ca²⁺ Spark/STOC coupling and elevated blood pressure. *Circ Res*. 2000;87:E53–E60.
- Schubert R, Serebryakov VN, Engel H, Hopp H-H. Iloprost activates K_{Ca} channels of vascular smooth muscle cells: role of cAMP-dependent protein kinase. *Am J Physiol*. 1996;271:C1203–C1211.
- Schubert R, Noack T, Serebryakov VN. Protein kinase C reduces the K_{Ca} current of rat tail artery smooth muscle cells. *Am J Physiol*. 1999;276:C648–C658.
- Gaynullina D, Lubomirov LT, Sofronova SI, Kalenchuk VU, Gloe T, Pfitzer G, Tarasova OS, Schubert R. Functional remodelling of arterial endothelium during early postnatal development in rats. *Cardiovasc Res*. 2013;99:612–621.
- Puzdrova VA, Kudryashova TV, Gaynullina DK, Mochalov SV, Aalkjaer C, Nilsson H, Vorotnikov AV, Schubert R, Tarasova OS. Trophic action of sympathetic nerves reduces arterial smooth muscle Ca²⁺ sensitivity during early post-natal development in rats. *Acta Physiol (Oxf)*. 2014;212:128–141.
- Mulvany MJ, Halpern W. Contractile properties of small arterial resistance vessels in spontaneously hypertensive and normotensive rats. *Circ Res*. 1977;41:19–26.
- Fasolato C, Pozzan T. Effect of membrane potential on divalent cation transport catalyzed by the “electroneutral” ionophores A23187 and ionomycin. *J Biol Chem*. 1989;264:19630–19636.
- Trendelenburg U, Maxwell RA, Pluchino S. Methoxamine as a tool to assess the importance of intraneuronal uptake of l-norepinephrine in the cat’s nictitating membrane. *J Pharmacol Exp Ther*. 1970;172:91–99.
- Galvez A, Gimenez Gallego G, Reuben JP, Roy Contancin L, Feigenbaum P, Kaczorowski GJ, Garcia ML. Purification and characterization of a unique, potent, peptidyl probe for the high conductance calcium-activated potassium channel from venom of the scorpion buthus tamulus. *J Biol Chem*. 1990;265:11083–11090.
- Salom JB, Barbera MD, Centeno JM, Orti M, Torregrosa G, Alborch E. Relaxant effects of sodium nitroprusside and NONOates in rabbit basilar artery. *Pharmacology*. 1998;57:79–87.
- Vo PA, Reid JJ, Rand MJ. Attenuation of vasoconstriction by endogenous nitric oxide in rat caudal artery. *Br J Pharmacol*. 1992;107:1121–1128.
- Pak KJ, Geary GG, Duckles SP, Krause DN. Male-female differences in the relative contribution of endothelial vasodilators released by rat tail artery. *Life Sci*. 2002;71:1633–1642.
- Bates JN, Baker MT, Guerra R Jr, Harrison DG. Nitric oxide generation from nitroprusside by vascular tissue: evidence that reduction of the nitroprusside anion and cyanide loss are required. *Biochem Pharmacol*. 1991;42(suppl):S157–S165.
- Kruszyna H, Magyar JS, Rochelle LG, Russell MA, Smith RP, Wilcox DE. Spectroscopic studies of nitric oxide (NO) interactions with cobalamins: reaction of NO with superoxocobalamin (III) likely accounts for cobalamin reversal of the biological effects of NO. *J Pharmacol Exp Ther*. 1998;285:665–671.
- Pinilla L, Tena-Sempere M, Aguilar E. Nitric oxide stimulates growth hormone secretion in vitro through a calcium- and cyclic guanosine monophosphate-independent mechanism. *Horm Res*. 1999;51:242–247.
- Alexander K, Volini M. Properties of an escherichia coli rhodanese. *J Biol Chem*. 1987;262:6595–6604.
- Filipovic MR, Eberhardt M, Prokopovic V, Mijuskovic A, Orescanin-Dusic Z, Reeh P, Ivanovic-Burmazovic I. Beyond H₂S and NO interplay: hydrogen sulfide and nitroprusside react directly to give nitroxyl (HNO): a new pharmacological source of HNO. *J Med Chem*. 2013;56:1499–1508.
- Asimakopoulou A, Panopoulos P, Chasapis CT, Coletta C, Zhou Z, Cirino G, Giannis A, Szabo C, Spyroulias GA, Papapetropoulos A. Selectivity of commonly used pharmacological inhibitors for cystathionine beta synthase (CBS) and cystathionine gamma lyase (CSE). *Br J Pharmacol*. 2013;169:922–932.
- Yang G, Wang R. H₂S and blood vessels: an overview. *Handb Exp Pharmacol*. 2015;230:85–110.
- Bonaventura D, de Lima RG, Vercesi JA, da Silva RS, Bendhack LM. Comparison of the mechanisms underlying the relaxation induced by two nitric oxide donors: sodium nitroprusside and a new ruthenium complex. *Vascul Pharmacol*. 2007;46:215–222.
- Garthwaite J, Southam E, Boulton CL, Nielsen EB, Schmidt K, Mayer B. Potent and selective inhibition of nitric oxide-sensitive guanylyl cyclase by 1-h-[1,2,4]oxadiazolo[4,3-a]quinoxalin-1-one. *Mol Pharmacol*. 1995;48:184–188.
- Butt E, Pöhler D, Genieser H-G, Huggins JP, Bucher B. Inhibition of cyclic GMP-dependent protein kinase-mediated effects by (Rp)-8-bromo-PET-cyclic GMPs. *Br J Pharmacol*. 1995;116:3110–3116.
- Waldron GJ, Cole WC. Activation of vascular smooth muscle K⁺ channels by endothelium-derived relaxing factors. *Clin Exp Pharmacol Physiol*. 1999;26:180–184.
- Lagrutta A, Wang J, Fermi B, Salata JJ. Novel, potent inhibitors of human Kv1.5 K⁺ channels and ultrarapidly activating delayed rectifier potassium current. *J Pharmacol Exp Ther*. 2006;317:1054–1063.
- Escoubas P, Diochot S, Celerier ML, Nakajima T, Lazdunski M. Novel tarantula toxins for subtypes of voltage-dependent potassium channels in the Kv2 and Kv4 subfamilies. *Mol Pharmacol*. 2002;62:48–57.
- Greenwood IA, Ohya S. New tricks for old dogs: KCNQ expression and role in smooth muscle. *Br J Pharmacol*. 2009;156:1196–1203.
- Schubert R, Krien U, Wulfsen I, Schiemann D, Lehmann G, Ulfing N, Veh RW, Schwarz JR, Gago H. Nitric oxide donor sodium nitroprusside dilates rat small arteries by activation of inward rectifier potassium channels. *Hypertension*. 2004;43:891–896.
- Quast U, Cook NS. Moving together: K channel openers and ATP-sensitive K channels. *Trends Pharmacol Sci*. 1989;10:431–435.
- Miller MR, Megson IL. Recent developments in nitric oxide donor drugs. *Br J Pharmacol*. 2007;151:305–321.

46. Napoli C, Ignarro LJ. Nitric oxide-releasing drugs. *Annu Rev Pharmacol Toxicol*. 2003;43:97–123.
47. Taylor MS, Okwuchukwuasanya C, Nickl CK, Tegge W, Brayden JE, Dostmann WR. Inhibition of cGMP-dependent protein kinase by the cell-permeable peptide DT-2 reveals a novel mechanism of vasoregulation. *Mol Pharmacol*. 2004;65:1111–1119.
48. Valtcheva N, Nestorov P, Beck A, Russwurm M, Hillenbrand M, Weinmeister P, Feil R. The commonly used cGMP-dependent protein kinase type I (cGKI) inhibitor Rp-8-br-PET-cGMPS can activate cGKI in vitro and in intact cells. *J Biol Chem*. 2009;284:556–562.
49. Karaki H, Sato K, Ozaki H, Murakami K. Effects of sodium nitroprusside on cytosolic calcium level in vascular smooth muscle. *Eur J Pharmacol*. 1988;156:259–266.
50. Chen XL, Rembold CM. Nitroglycerin relaxes rat tail artery primarily by lowering Ca^{2+} sensitivity and partially by repolarization. *Am J Physiol*. 1996;271:H962–H968.
51. Ruiz-Velasco V, Zhong J, Hume JR, Keef KD. Modulation of Ca^{2+} channels by cyclic nucleotide cross activation of opposing protein kinases in rabbit portal vein. *Circ Res*. 1998;82:557–565.
52. Blatter LA, Wier WG. Nitric oxide decreases $[Ca^{2+}]_i$ in vascular smooth muscle by inhibition of the calcium current. *Cell Calcium*. 1994;15:122–131.

The Unexpected Role of Calcium-Activated Potassium Channels: Limitation of NO-Induced Arterial Relaxation

Johannes Schmid, Bettina Müller, David Heppeler, Dina Gaynullina, Mario Kassmann, Hristo Gagov, Mitko Mladenov, Maik Gollasch and Rudolf Schubert

J Am Heart Assoc. 2018;7:e007808; originally published March 24, 2018;

doi: 10.1161/JAHA.117.007808

The *Journal of the American Heart Association* is published by the American Heart Association, 7272 Greenville Avenue, Dallas, TX 75231
Online ISSN: 2047-9980

The online version of this article, along with updated information and services, is located on the World Wide Web at:

<http://jaha.ahajournals.org/content/7/7/e007808>